



Product Name: CB-18 Anchor

Part #: 00652; 00654; 00656; 00657; 00658; 00659; 10652; 10655; 10656; 10683

Instruction Manual

Do not throw away these instructions!
Read and understand these instructions before using equipment!

Introduction	1
Applicable Safety Standards	1
Worker Classifications	2
Product Specific Applications	2
Limitations	3 - 4
Components and Specifications	4
Installation and Use	5 - 7
Maintenance, Cleaning, and Storage	7
Inspection	8
Inspection Log	8
Safety Information	9
Labels	10

Introduction

Thank you for purchasing a Guardian CB-18. This manual must be read and understood in its entirety, and used as part of an employee training program as required by OSHA or any applicable state agency.

This and any other included instructions must be made available to the user of the equipment. The user must understand how to safely and effectively use the CB-18, and all fall safety equipment used in combination with the CB-18.

User Information	
Date of First Use:	_____
Serial #:	_____
Trainer:	_____
User:	_____

Applicable Safety Standards

When used according to instruction specifications, this product meets or exceeds all applicable OSHA 1926.502 and OSHA 1910.140 standards for fall protection. This product has been tested in compliance with the requirements of ANSI/ASSP Z359.18. Testing only covers hardware and does not extend to the anchorage or substrate to which this product is attached. Applicable standards and regulations depend on the type of work being done, and also might include state-specific regulations. Consult regulatory agencies for more information on personal fall arrest systems and associated components.

CB-18 Anchors do not comply with ANSI/IWCA I-14.1-2001 Section 9 requirements for tie-back/suspension anchorages for window washing or facade maintenance equipment.

CB-18 Anchors do not comply with CalOSHA section 3291 (f) for roof tie-back/suspension anchorages, which are required on all buildings in California above 36' (or three stories), with certain rare exceptions.

Contact Guardian's Engineered Services Group (ESG) for more information or for anchors compliant with CalOSHA and/or IWCA standards.

PRODUCT COMPLIANCE	OSHA 1910.140 & OSHA 1926.502	ANSI Z359.18
Wood Installations	YES	NO
Metal Installations	YES	NO
Concrete Installations	YES	YES
Backer Plate Installations	YES	YES
Welding Installations	YES	YES

Worker Classifications



Understand the following definitions of those who work near or who may be exposed to fall hazards.

Qualified Person: A person with an accredited degree or certification, and with extensive experience or sufficient professional standing, who is considered proficient in planning and reviewing the conformity of fall protection and rescue systems.

Competent Person: A highly trained and experienced person who is ASSIGNED BY THE EMPLOYER to be responsible for all elements of a fall safety program, including, but not limited to, its regulation, management, and application. A person who is proficient in identifying existing and predictable fall hazards, and who has the authority to stop work in order to eliminate hazards.

Authorized Person: A person who is assigned by their employer to work around or be subject to potential or existing fall hazards.

It is the responsibility of a Qualified or Competent person to supervise the job site and ensure all applicable safety regulations are complied with.

Product Specific Applications



Use of equipment in unintended applications may result in serious injury or death. Maximum 1 attachment per connection point.



Personal Fall Arrest: CB-18 Anchors may be used to support a MAXIMUM 1 personal fall arrest system (PFAS) for use in Fall Arrest applications. Structure must withstand loads applied in the directions permitted by the system of at least 5,000 lb., or achieve a minimum 2:1 safety factor, as determined by a Qualified Person. Maximum free fall is 6', or up to 12' if used in combination with equipment explicitly certified for such use. **If PFAS anchor point is intended for permanent installation, it must be designed for use in Fall Arrest.** Applicable D-ring: Dorsal.



Restraint: CB-18 Anchors may be used in Restraint applications. Restraint systems prevent workers from reaching the leading edge of a fall hazard. Always account for fully deployed length of lanyard/SRL. Structure must withstand loads applied in the directions permitted by the system of at least 1,000 lb. No free fall is permitted. Restraint systems may only be used on surfaces with slopes up to 4/12 (vertical/horizontal). Applicable D-rings: Dorsal, Chest, Side, Shoulder.



Work Positioning: CB-18 Anchors may be used in Work Positioning applications. Work Positioning systems allow a worker to be supported and work freely with both hands. Structure must withstand loads applied in the directions permitted by the system of at least 3,000 lb. Maximum allowable free fall is 2'. Applicable D-rings: Side.



Rescue/Confined Space: CB-18 Anchors may be used in Rescue/Confined Space applications. Rescue systems function to safely recover a worker from a confined location or after exposed to a fall. There are various configurations of Rescue systems depending on the type of rescue. Structure must withstand loads applied in the directions permitted by the system of at least 3,000 lb. No free fall is permitted. Applicable D-rings: Dorsal, Chest, Shoulder.

For all applications: worker weight capacity range (including all clothing, tools, and equipment) is 130-420 lbs.

Limitations

Fall Clearance: There must be sufficient clearance below the anchorage connector to arrest a fall before the user strikes the ground or an obstruction. When calculating fall clearance, account for a MINIMUM 2' safety factor, deceleration distance, user height, length of lanyard/SRL, harness stretch, and all other applicable factors.

Diagram shown is an example fall clearance calculation ONLY.

Swing Falls: Prior to installation or use, make considerations for eliminating or minimizing all swing fall hazards. Swing falls occur when the anchor is not directly above the location where a fall occurs. Always work as close to in line with the anchor point as possible. Swing falls significantly increase the likelihood of serious injury or death in the event of a fall.

Compatibility: When making connections with CB-18, eliminate all possibility of roll-out. Roll-out occurs when interference between a hook and the attachment point causes the hook gate to unintentionally open and release. All connections must be selected and deemed compatible with CB-18 by a Competent Person. All connector gates must be self-closing and self-locking, and withstand minimum loads of 3,600 lbs. See the following for examples of compatible/incompatible connections:

Fall clearance calculation shown based on standing worker falling directly in-line with anchor point. Always consider potential swing fall and other hazards when calculating fall clearance.

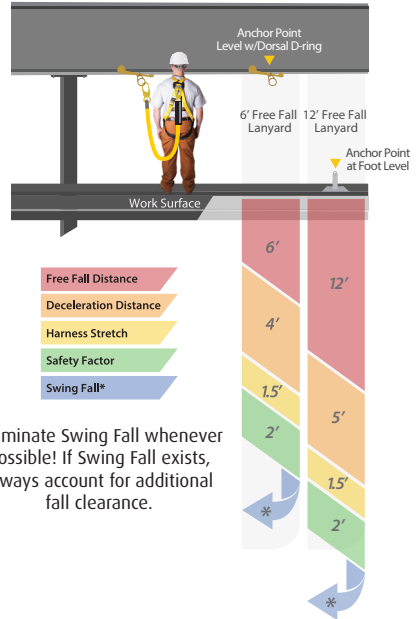

*Eliminate Swing Fall whenever possible! If Swing Fall exists, always account for additional fall clearance.

Connector closed and locked to D-ring. **OK.**

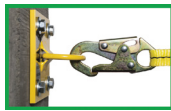

Two connectors to same D-ring. **NO.**



Incompatible or irregular application, which may increase risk of roll-out. **NO.**



Two or more snap hooks or carabiners connected to each other. **NO.**



Connector to integral lanyard. **NO.**



Connector directly to webbing. **NO.**



Connector directly to horizontal lifeline. **NO.**



Correct Anchorage Positioning:

This chart details allowable working zones required to reduce risk of swing falls and improper side loading. ALWAYS adhere to information specified by chart.

Anchor Distance From Leading Edge (Y)	Working Distance Along Roof Edge (Either Direction) (X)	Working Angle From Perpendicular (θ)
6'	8'	53°
10'	9' - 9"	45°
15'	11' - 7"	38°
20'	13' - 3"	33°
25'	14' - 6"	30°
30'	16'	28°
35'	17' - 2"	26°
40'	18' - 3"	24°
45'	19' - 4"	23°
50'	19' - 10"	21°
55'	21' - 4"	21°
60'	22' - 3"	21°

For example, if the anchorage connector is 6' from the leading edge (Y), the working distance (X) is 8' in each direction from the perpendicular, which translates to a 53° working angle.

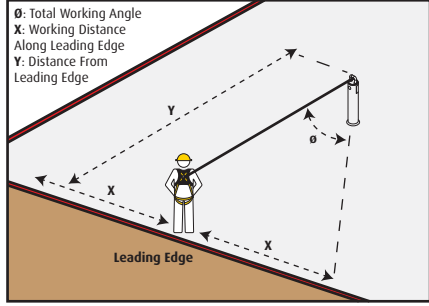

Components and Specifications

Type A anchorage connector.

Minimum permitted service temperature: -30° F.

5,000 lb. MBS (minimum breaking strength).

Materials: galvanized steel.

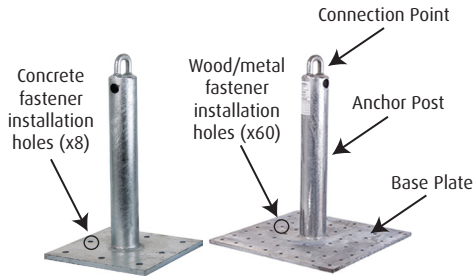

Standard	Swivel Top	Post	Base	Description
#00656	#00652	18"	12" x 12"	CB-18 Anchor for Concrete Applications
#10655	#10652	18"	-	CB-18 Weld-On Anchor
#10656	-	18"	-	CB-18 Weld-On Anchor w/Pass-Through Top
#10683	-	-	12" x 12"	CB-18 Backer Plate
#00658	-	18"	12" x 12"	CB-18 Anchor w/Pass-Through Top for Concrete Applications
#00657	#00654	18"	16" x 16"	CB-18 Anchor for Wood & Metal Applications
#00659	-	18"	16" x 16"	CB-18 Anchor w/Pass-Through Top for Wood & Metal Applications

Installation and Use



All installation of CB-18 Anchors **MUST** be approved by a Competent or Qualified Person, or by a Guardian Fall Protection certified installer.

MINIMUM substrate thickness requirements:

- Wood: 3/4" CDX.
- Metal: 18 gauge, or 20 gauge if reinforced with CB Spanner Plate (part # 00604, contact Guardian for more information).
- Concrete: 6", 2,500 psi or better.

Substrate fastener requirements:

- Wood: #14 x 10, 2" wood deck screws. Qty. 60.
- Metal: #14 x 14, 2" metal deck screws. Qty. 60. Please note that longer screws may be required in order to achieve the minimum necessary substrate penetration. All fasteners must penetrate metal decking by at least 1/4".
- Concrete: 1/2" x 3" concrete bolts. Qty. 8.

CB-18 roof slope compatibility: flat - sheer. Any installation past sheer (for example, on the underside of a beam) must be done in combination with backer plate.

Prior to use, plan your system:

1. Ensure all PFAS equipment is selected and deemed compatible with CB-18 by a Competent Person.
2. Eliminate or minimize all risk of swing fall.
3. Ensure structure to which CB-18 is to be installed, and on which work is to be performed, is free of all hazards, including, but not limited to, debris, rot, rust, sharp or abrasive edges and surfaces, and hazardous materials.
4. A Qualified Person must determine that structure to which CB-18 is to be installed is rated to withstand minimum required loads. There are no minimum or maximum spacing requirements for CB-18 Anchors, provided structure is of sufficient strength.
5. For all CB-18 Anchors, all applicable fastener holes **MUST** be used and all fasteners **MUST** be fully embedded in substrate. **NEVER** over-tighten fasteners.
6. CB-18 is rated for loading in any direction provided it is installed as prescribed. Suitable for use in HLL applications.

Installation, CB-18

Wood Install (part #s 00654, 00657, and 00659):

MINIMUM substrate requirement: 3/4" thick CDX.

1. Place CB-18 at selected installation location.
2. Install all (60) fasteners until snug, and ensure CB-18 is fully secured to substrate.
3. All fasteners **MUST** be fully embedded in wood decking.

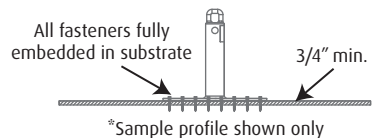

Metal Install (part #s 00654, 00657, and 00659):

MINIMUM substrate requirement: 18 gauge, or 20 gauge if reinforced with CB Spanner Plate (part # 00604, contact Guardian for more information).

1. Place CB-18 at selected installation location.
2. Install all (60) fasteners until snug, and ensure CB Anchor is fully secured to substrate.
3. All fasteners MUST penetrate metal decking by at least $\frac{1}{4}$ ".

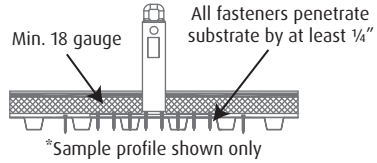

Concrete Install (part #s 00652, 00656, and 00658):

MINIMUM substrate requirement: 6" thick, 2,500 psi.

Installation must be done a MINIMUM 8" from all fall hazards.

1. Place CB-18 at selected installation location.
2. Install all (8) fasteners until snug, and ensure CB-18 is fully secured to substrate.
3. Always refer to fastener manufacturer's instructions regarding fastener installation.

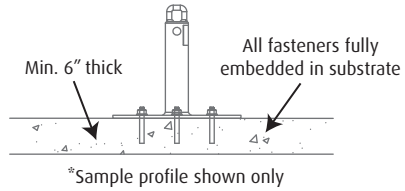

Backer Plate Install:

Compatible beam width: 6" - 8" *.

1. Place CB-18 at compatible installation location.
2. Secure Backer Plate to CB-18 with (4) $\frac{1}{2}$ " threaded rods. (2) $\frac{1}{2}$ " lock washers and (2) $\frac{1}{2}$ " hex nuts required per threaded rod.
3. Tighten all fasteners until snug, and ensure CB-18 is secured to substrate.
4. Deform threads on all fasteners to prevent tampering.

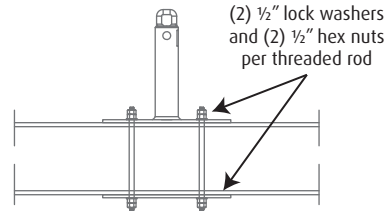

*Backer plate installation may also be done on structural member other than I-beam, provided structural member is deemed compatible by jobsite Competent Person

Installation, CB-18 Weld-On (part # 10652, 10655, and 10656)

CB-18 Weld-On Post must be installed by an American Welding Society (AWS) certified welder in accordance with all applicable welding regulations.

Post diameter: 2 7/8"

Fillet weld: 5/16"

Minimum beam flange width: 3 1/2"

After welding, allow the anchor to cool to ambient temperature. Once the anchor is fully cooled, remove the plastic plug from the top of the post and fill the hollow portion with insulating spray foam. Trim any excess foam from the plug hole and reinsert the plastic plug to seal the anchor from environmental exposure.

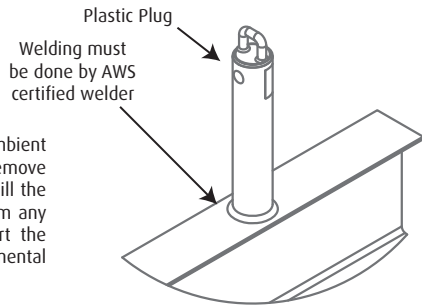

Maintenance, Cleaning, and Storage

If CB-18 fails inspection in any way, immediately remove it from service, and contact Guardian to inquire about its return or repair. Field serviceability testing is not required, and should not be done by the end user.

Cleaning after use is important for maintaining the safety and longevity of CB-18. Remove all dirt, corrosives, and contaminants from CB-18 before and after each use. If CB-18 cannot be cleaned with plain water, use mild soap and water, then rinse and wipe dry. NEVER clean CB-18 with corrosive substances.

When not in use, store equipment where it will not be affected by heat, light, excessive moisture, chemicals, or other degrading elements.





Inspection

Prior to EACH use, inspect CB-18 for deficiencies, including, but not limited to, corrosion, deformation, pits, burrs, rough surfaces, sharp edges, cracking, rust, paint buildup, excessive heating, alteration, and missing or illegible labels. IMMEDIATELY remove CB-18 from service if defects or damage are found, or if exposed to forces of fall arrest.

Ensure that applicable work area is free of all damage, including, but not limited to, debris, rot, rust, decay, cracking, and hazardous materials. Ensure that selected work area will support the application-specific minimum loads set forth in this instruction manual. Work area MUST be stable.

At least every 12 months, a Competent Person other than the user must inspect CB-18. **Competent Person inspections MUST be recorded in inspection log in instruction manual and on equipment inspection grid label. The Competent Person must sign their initials in the box corresponding to the month and year the inspection took place.**

During inspection, consider all applications and hazards CB-18 have been subjected to.

Inspection Log

Date of First Use: _____.

Product lifetime is indefinite as long as it passes pre-use and Competent Person inspections. User must inspect prior to EACH use. Competent Person other than user must complete formal inspection at least every 12 months. Competent Person to inspect and initial.

	J	F	M	A	M	J	J	A	S	O	N	D
YR												
YR												
YR												
YR												
YR												

This inspection log must be specific to one CB-18. Separate inspection logs must be used for each CB-18. All inspection records must be made visible and available to all users at all times.

If equipment fails inspection IMMEDIATELY REMOVE FROM SERVICE.

Safety Information



Failure to understand and comply with safety regulations may result in serious injury or death. Regulations included herein are not all-inclusive, are for reference only, and are not intended to replace a Competent Person's judgment or knowledge of federal or state standards.

Do not alter equipment. Do not misuse equipment.

Workplace conditions, including, but not limited to, flame, corrosive chemicals, electrical shock, sharp objects, machinery, abrasive substances, weather conditions, and uneven surfaces, must be assessed by a Competent Person before fall protection equipment is selected.

The analysis of the workplace must anticipate where workers will be performing their duties, the routes they will take to reach their work, and the potential and existing fall hazards they may be exposed to. Fall protection equipment must be chosen by a Competent Person. Selections must account for all potential hazardous workplace conditions. All fall protection equipment should be purchased new and in an unused condition.

Fall protection systems must be selected and installed under the supervision of a Competent Person, and used in a compliant manner. Fall protection systems must be designed in a manner compliant with all federal, state, and safety regulations. Forces applied to anchors must be calculated by a Competent Person.

Unless explicitly stated otherwise, the maximum allowable free fall distance for lanyards must not exceed 6'. No free fall allowed for non-LE SRLs.

Harnesses and connectors selected must be compliant with manufacturer's instructions, and must be of compatible size and configuration. Snap hooks, carabiners, and other connectors must be selected and applied in a compatible fashion. All risk of disengagement must be eliminated. All snap hooks and carabiners must be self-locking and self-closing, and must never be connected to each other.

A pre-planned rescue procedure in the case of a fall is required. The rescue plan must be project-specific. The rescue plan must allow for employees to rescue themselves, or provide an alternative means for their prompt rescue. Store rescue equipment in an easily accessible and clearly marked area.

Training of Authorized Persons to correctly erect, disassemble, inspect, maintain, store, and use equipment must be provided by a Competent Person. Training must include the ability to recognize fall hazards, minimize the likelihood of fall hazards, and the correct use of personal fall arrest systems.

NEVER use fall protection equipment of any kind to hang, lift, support, or hoist tools or equipment, unless explicitly certified for such use.

Equipment subjected to forces of fall arrest must immediately be removed from use.

Age, fitness, and health conditions can seriously affect the worker should a fall occur. Consult a doctor if there is any reason to doubt a user's ability to withstand and safely absorb fall arrest forces or perform set-up of equipment. Pregnant women and minors must not use this equipment.

Physical harm may still occur even if fall safety equipment functions correctly. Sustained post-fall suspension may result in serious injury or death. Use trauma relief straps to reduce the effects of suspension trauma.

Labels



CB-18 Anchor

PART#: **DOM:**

SERIAL#: **LOT#:**

Prior to use, read and understand all manufacturer's instructions provided with equipment at time of shipment.

⚠ WARNING

MAXIMUM 1 attachment per Anchor.

Keep away from all potential hazards, including, but not limited to, heat, electricity, chemicals, and sharp or abrasive edges and surfaces. Compliant with OSHA 1926.502, OSHA 1910.140, and ANSI/ASSP Z359.18* regulations. *Depending on application. Refer to instructions for more details.

Only make compatible connections. Refer to instructions for proper installation and connection methods. All PFAS equipment must be selected and deemed compatible with CB-12 Anchor by a Competent Person. Worker capacity range (including all equipment): 130-420 lb.

Materials: Galvanized steel
Type A anchorage connector,
5,000 lb. MBS (minimum breaking strength).
Minimum service temperature: -30° F.

INSPECTION GRID

User must inspect prior to EACH use. Competent Person must complete formal inspection every 12 months. Competent Person to inspect and initial. Product lifetime is indefinite as long as equipment passes pre-use and Competent Person inspections. If equipment fails inspection IMMEDIATELY REMOVE FROM SERVICE.

Initials: **Date:**

Date of First Use:

90894 Rev. C

DO NOT REMOVE LABEL

Made in China

